

XC3-40500-RF

Multi-Function RGB Controller

Product Features

- 4-Channel RGB+W Control.
- Receiver has 10 built-in color modes.
- 8 Levels of brightness and 256 gray-level adjustments.
- Remote Control has both touch and color ring controls.
- The RF remote operation distance is 33 feet.
- Remote Control requires 3 AAA batteries (Not included).
- Automatic power-off memory function.
- Short-circuit protection, over-current and over-heat protection.

Product Specifications

- Input Voltage 12-24VDC
- Output Current 5A per channel
- Output Power 12V: 240W; 24V: 480W
- Channel (s) 4
- Remote Type RF
- Operation Temperature -35 ~ 55 °C
- Controller Dimensions (L)65 x (W)64 x (H)24 (mm), 2.56 x 2.52 x 0.94 (inch)
- Remote Dimensions (L)114 x (W)55 x (H)21 (mm), 4.49 x 2.17 x 0.83 (inch)
- Weight 130g



Scene Modes

1: RGB Fading	6: 3-Color jump change
2: RG Fading	7: Full-color jump change
3: RB Fading	8: Red Flashing
4: GB Fading	9: Green Flashing
5: Full-color Fading	10: Blue Flashing







XC3-40500-RF

Multi-Function RGB Controller

RGB Controller

XC3-40500-RF

Remote Control

-  **On/Off:** Turn On/Turn off.
-  **Mode:** Change to next scene (Total 10 scenes).
-  **White Light Mode:** Select the white light mode.
-  **Brightness-:** Decreases brightness level (Total 8 levels).
-  **Brightness+:** Increases brightness level (Total 8 levels).
-  **Color Ring:** Move your finger along the color ring to select a color.



Remarks:

- (1) Please do not touch the color ring or press buttons while installing the batteries.
- (2) After the batteries are installed, please wait for at least 3 seconds to use the remote.
- (3) If the color ring or buttons are non-responsive, please reinstall the batteries.



Remote Sync:

Each remote has a unique ID code and a range of about 33 feet. The LED controller can memorize up to 20 remote ID codes at one time. If there are more than 20 ID codes, the oldest code will be deleted. The power off memory function will retain the last ID code and set the scene accordingly.

- **To Sync the LED controller with a remote:** Power up the controller, then, press and hold the  (Brightness+) button for 3 seconds. If the synchronization is successful, then LED light will blink 3 times.
- **Clear ID code in controller:** You can clear a code from an LED controller by powering up the controller, and then, press the  (Brightness+) button 6 times within 3 seconds. If successful, the LED light will blink 6 times.

XC3-40500-RF

Multi-Function RGB Controller

Connection Instructions

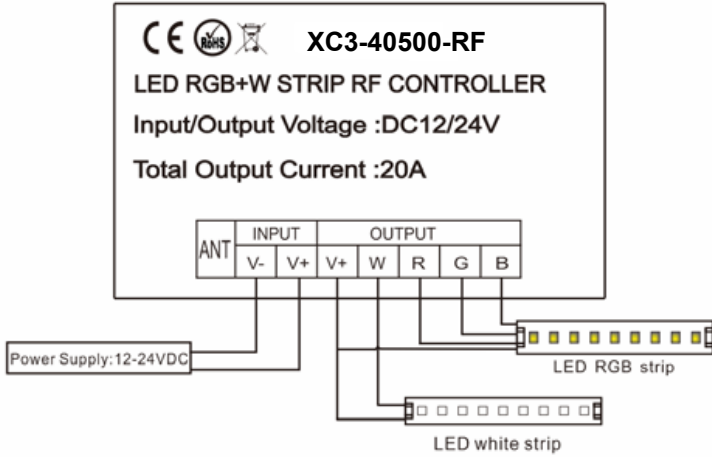

Troubleshooting Guides

Problem	Reason	Solution
All lights are off with power on.	No Power.	Check the power source.
	Dimmer protection function is triggered.	Check error and reconnect the power cord.
	Power cord is not connected properly.	Reconnect the power cord.
Wrong color.	RGB wires are not connected properly.	Check RGB wires.
Remote control has no response.	Battery is not installed properly.	Re-load the battery.
	Beyond the remote distance.	Move remote closer to the dimmer.
Remote responds so slow.	Battery has no enough power.	Change to a new battery.
Abnormal flicker.	Wires are too long.	Shorten the wires or use loop power supply.
	Wire's diameter is too small.	Use a bigger wire.
	Dimmer or power supply is overloaded.	Add more signal amplifiers.
Signal Confusion.	Interfered by another remote.	Clear ID code list in dimmer (See Remote Sync on page 2).